



rotierende Polierwerkzeuge  
rotating polishing instruments

2020  
2021  
2022  
2023

2024

2025



DENTAL

# Das **hatho** Team

## The HATHO Team

Kunden-Dienst versteht HATHO wortwörtlich. Verstehen beginnt mit zuhören. HATHO hört auf die Wünsche seiner Partner und Kunden. Daraus erwächst eine Service-Kette, die schon mit der Produktentwicklung beginnt. HATHO Produkte entstehen als Antwort auf die Bedürfnisse der Anwender. Die Kundenbetreuung prägt ein Höchstmaß an Information und Schulung einerseits und eine produkt-, mengen- und zeitgenaue Lieferung andererseits. Das Feedback der Zufriedenheit gibt wiederum den Ansporn zu stetiger Verbesserung. Langfristige und erfolgreiche Zusammenarbeit sind die Früchte des HATHO Service-Konzepts.

HATHO understands the importance of customer service and understanding begins with listening. HATHO listens to the concerns and the wishes of its partners and customers, giving rise to a range of services beginning with product development. HATHO products are specifically designed to meet client's needs. The path to the user is made easy by HATHO through intensive commercial support i.e. with the best possible information and training and with the timely delivery of requested products.



**Christina Schütz**  
Vertriebsleiterin  
Head of Distribution



**Britta Menzel**  
Assistentin der  
Geschäftsleitung  
Assistant to the  
Managing Director



**Dr. Ralf Steiner**  
Geschäftsführer  
Managing Director



**Sean Kenny**  
Junior Direktor  
Junior Director



**Andreas Chmieliczek**  
Verkaufsleiter  
Head of Sales

# hatho



Die Produktion und die Verwaltung der Firma HATHO GmbH befinden sich im Gewerbepark Breisgau, einem Industriegebiet in Eschbach ca. 30 km südlich von Freiburg im Südwesten Deutschlands. In dieser reizvollen Umgebung im Rheintal, eingerahmt von den Vogesen und dem Schwarzwald, werden unsere hochwertigen HATHO Produkte produziert.

The company HATHO GmbH is located in the industrial park "Gewerbepark Breisgau" in Eschbach approximately 30 km south of Freiburg, in southwest Germany. All HATHO high quality products are manufactured here in the Rhine river valley.

<b>Anwendungsbereiche Polierpasten • Besonderheiten</b> Range of Application for polishing compounds • Specialities		4 - 5
Bürsten Brushes	▼ <b>Minischleifbürsten</b> Mini Grinding Brushes	6 - 7
	<b>HABRAS Bürsten</b> HABRAS Brushes	8 - 9
	<b>HABRAS Discs</b> HABRAS Discs	10 - 11
	▼ <b>Rundbürsten</b> Lathe Brushes	12 - 13
	<b>HoPla Rundbürsten</b> HoPla Lathe Brushes	14 - 15
	<b>Ideal - Einlagebürsten</b> Ideal - Multi Layer Brushes	16 - 19
▼ <b>Minipolierbürsten</b> Mini Polishing Brushes	<b>Slimline Bürsten und Schwabbeln</b> Slimline Brushes and Buffs	20 - 21
Schwabbeln Bufs	▼ <b>Schleifvliesräder</b> Abrasive Trimming Wheels	22 - 23
	▼ <b>Minischleifvliesräder</b> Mini Abrasive Trimming Wheels	24 - 25
	▼ <b>Polierschwabbeln</b> Polishing Buffs	26 - 29
	▼ <b>Minipolierschwabbeln</b> Mini Polishing Buffs	30 - 31
Schleif- und Polierkörper Grinder and Polishers	▼ <b>Minischleifkörper</b> Mini Grinder	32 - 33
	<b>HATHOfex</b> HATHOfex	34 - 35
	<b>Diastone + DiaDisc</b> Diastone + DiaDisc	36 - 37
▼ <b>Minipolierkörper</b> Mini Polishers	<b>Polierfilze</b> Felt Polishers	38 - 39
<b>Polistar Poliermittel</b> Polistar Polishing compounds	▼ <b>Pasten, Emulsion</b> Compounds, Emulsion	40 - 41
<b>Keramikpinsel</b> Ceramic Brushes	▼ <b>Keramikpinsel</b> Ceramic Brushes	42 - 43
Zubehör Accessories	▼ <b>FiberDisc, Mandrels, Handwerkzeuge, Adapterspindel</b> FiberDisc, Mandrels, Hand Tools, bur chuck	44 - 45
	▼ <b>Poliersets</b> Polishing Kits	46 - 47
	▼ <b>Werkzeugständer, Schutzkappe, Fingerlinge, Muster Kit</b> Instrument holder, Protector, Finger Stalls, Sample Kit	



		Vorpolitur pre-polishing	Glanzpolitur shine polishing	Hochglanzpolitur high shine polishing	Spiegelglanz mirror finish
	Acrylat Acrylate Prothesenkunststoff Denture Acrylic Thermoplast Thermoplastic				
	Makrofüller Macrofiller Komposit Composite Hybrid/Nano Hybrid/Nano				
	CoCrW CoCrW Modelguss Framework CoCrMo CoCrMo				
	AuPt Gold casting alloy Edelmetall Precious Metal PdAg Palladium - base				
	Nichtedelmetalle Non - Precious Metal				
	Keramik Ceramic				
	Titan Titanium				
	Zirkonoxyd Zirkonium oxyd Lithium-Disilikat Lithium-Disilicate				



## Besonderheiten Specialities



### Haare und Borsten Hair and bristles

Nur die beste Qualität für unsere Produkte  
Ziegenhaare (weich), Pferdehaare (mittel), Borsten (hart)

Only the best quality used for our products.  
Goat hair (soft), horse hair (medium), bristles (hard)



### HATHO HoPla

Eine Holzbuchse im  
Zentrum des Kunststoffkerns

Wooden center  
encased in plastic core



### HATHO Brechflansch HATHO removable ring system



Abbrechbares Ring-  
system zur seitlichen  
Stabilisierung der  
Schwabbeln

Removable ring  
system, provides  
lateral stability to  
polishing discs

### HATHO UniFix



Neuer Kunststoffkern mit abgestuftem Zentrum zur  
besseren Fixierung und Zentrierung der Polierschwabbeln

New plastic core with stepped arbour hole for  
better fixing and centering on the spindle

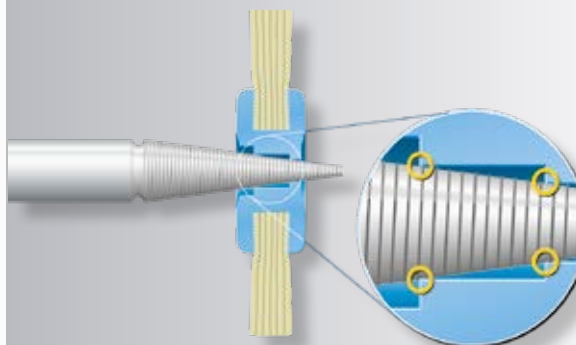

### HATHO FILIO<sup>®</sup>

Adapter zur Montage von Schaftbürsten auf  
Poliermotor ( S. 43 )

Adapter for mounting shank brushes on  
conical spindle of a polishing unit ( p. 43 )



## HABRAS Bürsten HABRAS Brushes

Das Besatzmaterial der HABRAS Bürsten besteht aus zähelastischen Polyamidfasern, die mit Schleifmitteln durchsetzt sind. Dadurch ist beim Einsatz keine Polierpaste nötig. HABRAS Bürsten haben eine sehr hohe Standzeit und werden beim Vorpolieren von Verblendkunststoffen und Dentalkeramiken eingesetzt. Die HABRAS Bürsten mit den hellgrauen, Aluminiumoxid durchsetzten Fasern, erzeugen auf Verblendkunststoffen eine homogene Oberflächenstruktur und bereiten diese optimal auf die folgende Glanz- und Hochglanzpolitur vor. Die mit Siliziumcarbid durchsetzten dunkelgrauen HABRAS Fasern geben Dentalkeramiken eine Oberflächenstruktur, die das Gelingen des Glanzbrandes bestens vorbereiten.

HABRAS brushes contain filling material made of elastic Polyamide fibers, blended with abrasives, which are distributed throughout the filament. When using these brushes no additional paste is necessary. HABRAS brushes have a very long lifespan. They are ideal for pre-polishing of veneer composites and dental ceramics. The light grey HABRAS brushes contain aluminum oxide as abrasive and optimally prepare veneer composites for the following gloss and final polishing. The dark grey HABRAS brushes contain silicon carbide and are used on dental ceramics to prepare the surface for glaze baking.



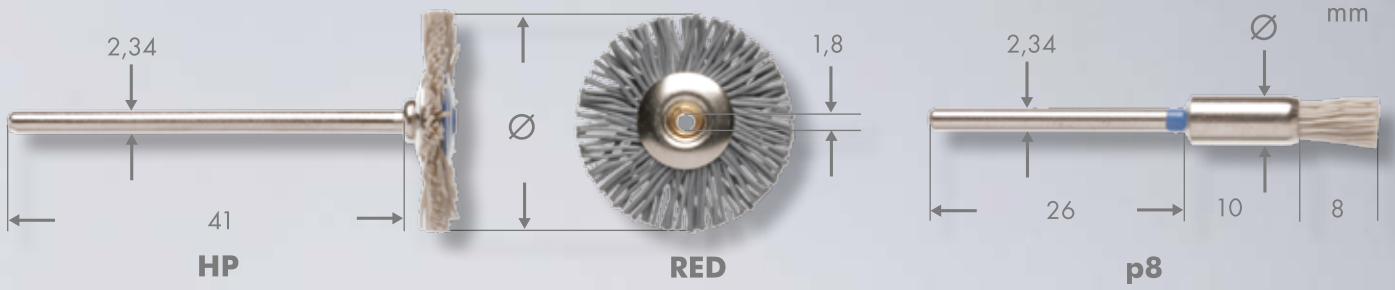

	Art.Nr. art.No.	VE PU	Farbcode colour code	Ø mm	Schleifkorn grit	Charakter character
	400 19 HP	4		19	AO	fein fine
	400 22 HP	4		22		
	400 22 RED	4		22		
	400 p8 HP	4		5		
	402 19 HP	4		19	AO	mittel medium
	402 22 HP	4		22		
	402 22 RED	4		22		
	402 p8 HP	4		5		
	404 19 HP	4		19	AO	grob coarse
	404 22 HP	4		22		
	404 22 RED	4		22		
	404 p8 HP	4		5		
	800 19 HP	4		19	SiC	extra fein extra fine
	800 22 HP	4		22		
	800 22 RED	4		22		
	800 p8 HP	4		5		
	410 19 HP	4		19	SiC	mittel medium
	410 22 HP	4		22		
	410 22 RED	4		22		
	410 p8 HP	4		5		
	420 19 HP	4		19	SiC	grob coarse
	420 22 HP	4		22		
	420 22 RED	4		22		
	420 p8 HP	4		5		













# HABRAS Discs, HABRAS Disc Pro

## HABRAS Discs, HABRAS Disc Pro

HABRAS Discs sind Scheibenbürsten aus weichem, mit Schleif- und Poliermitteln durchsetztem Polyamid. Das einzigartige Bürstendesign der dünnen Scheiben, in Verbindung mit der Auswahl von fein aufeinander abgestimmten Schleifmitteln, machen diese farbkodierten HABRAS Discs vielseitig einsetzbar. Vom Feinschliff über das Vorpulieren bis zum Hochglanz erledigen die flexiblen HABRAS Discs mühelos jeden Arbeitsgang. Prothesenkunststoffe, Composite und Edelmetalllegierungen lassen sich spielend leicht ohne zusätzliche Polierpaste polieren. Für Modellguss empfehlen wir die HABRAS Disc Pro. Bei den härteren Dentalkeramiken findet nur die grobe, gelbe Ausführung ihren Einsatz.

HABRAS Discs are wheel shaped brushes. They consist of soft polyamide in which abrasives are embedded. The discs, with their color, unique design and harmonized abrasives serve to enhance their effectiveness. Fine grinding, to pre-polishing and up to high shine polishing, these flexible tools have multiple application possibilities. Denture acrylics, composites and precious metal alloys can be treated without any additional compound. For the framework, we recommend HABRAS Disc Pro. For use on dental ceramics only the yellow discs comes into operation.



Ø 14 mm	Art.Nr. art.No.	Schleifkorn grit	Charakter character	VE PU
	905 14 ..	Korund corundum	mittel medium	..HP
	902 14 ..		standard standard	
	903 14 ..		fein fine	..R/4
	904 14 ..	Bimsstein pumice	sehr fein very fine	..R/48
	907 14 ..	Edelkorund high grade corundum	ultra fein ultra fine	
Ø 14 mm		<b>HABRAS Disc Pro</b>		
	905.1 14 PP	Korund corundum		<b>PP = PicoPlus</b> Spezial ISO-Schaft mit kleinem Nietkopf Ø 5,5 mm  Special ISO shank with small rivet Ø 5,5 mm
	903.2 14 PP			
	904.3 14 PP	Bimsstein pumice	<b>HABRAS Disc Pro DCS Kit 14 Sortiment Assortment</b>	

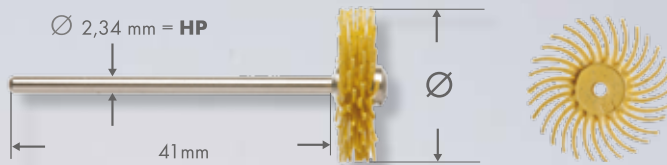

**VE = Verpackungseinheit**  
**PU = Packaging Unit**



**..HP**  
 Handpiece  
 4 Discs auf  
 Schraubmandrell  
 4 Discs on  
 screw mandrel.



**...R/4**

4 Discs lose im Beutel  
 4 Discs, loose, in a bag



**...R/48**





48 Discs lose im Beutel  
 48 Discs, loose, in a bag



**...(3)HP**

3 Discs auf Schaft fest montiert  
 3 Discs fix mounted on shank

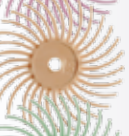

Ø 19 mm	Art.Nr. art.No.	Schleifkorn grit	Charakter character
	901 19 ..	Korund corundum	<b>grob</b> coarse
	902 19 ..		<b>standard</b> standard
	903 19 ..	Bimsstein pumice	<b>fein</b> fine
	904 19 ..		<b>sehr fein</b> very fine
	906 19 ..	Edelkorund high grade corundum	<b>extra fein</b> extra fine
	907 19 ..		<b>ultra fein</b> ultra fine



**HABRAS Discs Kit 19**

**Sortiment beinhaltet je ein HABRAS Disc ... 19 HP**  
 von grob bis ultrafein -  
 ganz ohne Polierpaste zum Hochglanz  
**Assortment including each one of ..19 HP  
 HABRAS Discs**  
 from coarse to ultra fine -  
 completely without polishing paste to high gloss

Ø  
25 mm

**HABRAS Disc Pro**



Korund corundum	<b>grob</b> coarse
	<b>standard</b> standard
	<b>fein</b> fine









## HoPla Rundbürsten HoPla Lathe Brushes

Die HATHO Rundbürsten mit HolzPlastikkern (HoPla) werden aus Chungking Borsten erster Qualität und aus ausgesuchten Haaren gefertigt. Die im Kunststoffkern eingebettete Holzbuchse gewährleistet ein leichtes Aufstecken und Abnehmen der HoPla-Rundbürste auf die konische Gewindespindel des Poliermotors. Der hohe Füllgrad und die gute Verankerung der Borstenbündel tragen wesentlich zur hohen Standzeit der HATHO HoPla-Bürsten bei. Die Rundbürsten mit längeren und daher weicheren Borstenbündeln finden Ihre Anwendung beim Vorpolieren von Prothesenkunststoffen, Kompositen und Edelmetalllegierungen. Die Rundbürsten mit kurzen und daher härteren Borstenbündeln eignen sich besonders für die Vorpolitur von NEM und CoCr.

HATHO lathe brushes with wooden and plastic cores (HoPla) are manufactured from best quality Chung King bristles and finest selected hair. The wooden core guarantees easy mounting and dismounting from the conical spindle of a polishing unit. The density of the bristles or hair in the bundle, the number of bundles per row and the well anchored bundles insures longevity and increased lifespan for the HoPla brushes. The lathe brushes with longer, softer bristles are used for the pre-polishing of dental acrylics, composites and precious metal alloys. Short trim length (harder) brushes are especially suitable for pre-polishing of non precious metals and CoCr alloys.







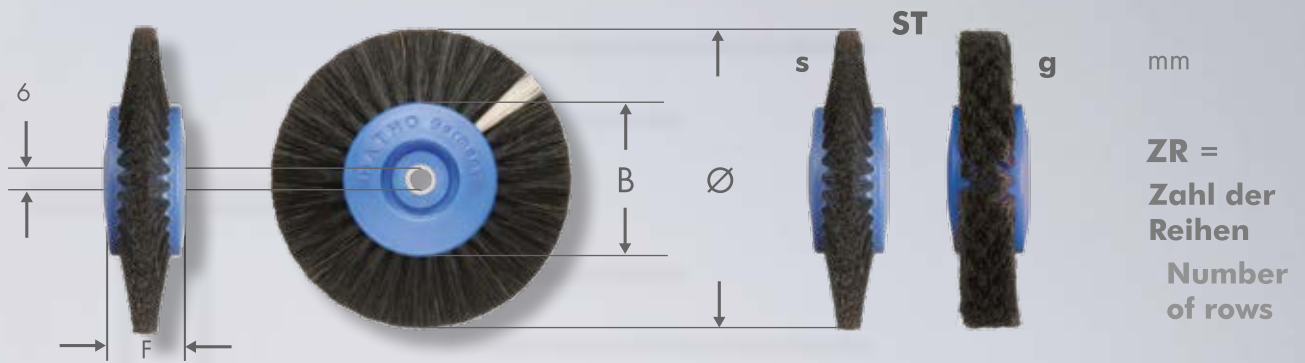

	Art.Nr. art.No.	VE PU	Besatzmaterial filling material	ZR	ST	Ø mm	B mm	F mm
	1144	12	schwarze Chungking Borsten  black Chung King bristles	1	-	44	25	6
	1145	12		1	S	45	25	12
	1245	12		2	S	45	25	13
	1250	12		2	S	50	25	13
	1260	12		2	S	60	45	13
	1270	12		2	S	70	50	12
	1355	12		3	S	55	28	17







	Art.Nr. art.No.	VE PU	Besatzmaterial filling material	ZR	ST	Ø mm	B mm	F mm
	1370	12	schwarze Chungking Borsten  black Chung King bristles	3	s	70	40	17
	146 EH	12		4	g	60	40	17
	1480	12		4	s	80	40	21
	148	12		4	g	80	40	21
	4R 80 121	12		4	s	80	40	21
	121 35 Palatinal	1		-		35	14	-
	100 80	12	weißes Ziegenhaar white goat hair	4	g	80	40	17

# Ideal - Einlagebürsten

## Ideal - Multi Layer Brushes

Die HATHO Ideal-Einlagebürsten sind hochwertige Rundbürsten mit ausgewählten Tuch- oder Vlieseinlagen zwischen einzelnen Borstenreihen. Dadurch verbessert sich die Aufnahme von festen oder flüssigen Poliermitteln. Die Kombination von feinen Borsten und weichen Tüchern oder Vlies ist ideal für das zügige Vorpulieren von Prothesenkunststoffen, Verblendkomposite und Edelmetalllegierungen. Die beiden kleinen Ideal-Einlagebürsten mit Vlieseinlage werden beim natürlichen Mattglanzpolieren von ästhetischen Frontzähnen aus Dentalkeramik eingesetzt.

HATHO Ideal - Multi-layer brushes are excellent lathe brushes, with specifically selected non-woven fiber cloth inserts, positioned between the bristle rows. This design increases the retention of liquid or firm polishing compounds on the brush. The combination of best quality bristles, soft cloth or non-woven fabric enables fast pre-polishing of denture acrylic, veneer composites and precious metal alloys. The smallest Ideal Multi-Layer brushes, with a white non-woven fiber insert, are produced for natural matt polishing of aesthetic anterior ceramic teeth.



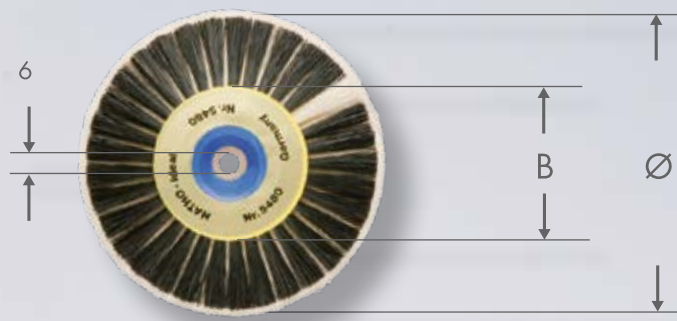

Art.Nr.	VE	Einlagematerial	Ø	ZBR	B	F
art.No.	PU	material inside	mm		mm	mm
5250	12	Nesselstoff muslin cloth	50	2	25	13
5380	12		80	3	40	18
5480	12		80	4	40	24
6380	12	Filztuch felt cloth	80	3	40	18
6480	12		80	4	40	24





mm

**ZBR = Zahl der  
Borstenreihen**  
Number of  
bristle rows

	Art.Nr.	VE PU	Einlagematerial material inside	Ø mm	ZBR	B mm	F mm
	8277	12	silikonierter Nesselstoff silicon coated muslin cloth	77	2	40	14
	9245	12		45	2	25	14
	9255	12	Scotch Brite™ Vlies	55	2	25	14
	9280	12	Scotch Brite™ insert	80	2	40	14
	8280	12	+ ZETA Tuch + ZETA cloth	80	2	40	21
	4280	12	Scotch Brite™ Vlies - fein Scotch Brite™ insert - fine	80	2	40	21





# Slimline Bürsten und Schwabbeln

## Slimline Brushes and Buffs









Die Besonderheit der Slimline Bürsten liegt in ihrer Konstruktion. Ein einziges Bündel an Haaren oder Borsten wird durch ein aufeinander abgestimmtes Ring-Nieten-System aufgefächert. Bei den Slimline Schwabbeln sind es dementsprechend verschiedene Lagen an Leder oder Tüchern.

Der innenliegende Kunststoffkern ermöglicht ein einfaches Auf- und Abmontieren der Slimline Bürsten und Schwabbeln auf die konische Spindel des Poliermotors. Die Vielfalt der Besatzmaterialien eignen sich je nach Wahl der verwendeten Polierpaste für alle Dentalmaterialien.

Slimline brushes have a specialized design and a sophisticated assembly process, producing a unique brush out of a large hair or bristle bundle. The Slimline buffs are made of leather or of various types of cloth. The plastic center allows for easy mounting and dismounting of Slimline brushes and buffs on a conical spindle. The various filing materials are suited to the different polishing compounds for use with all the dental work materials.



	Art.Nr. art.No.	VE PU	Besatzmaterial filling material	Charakter character	Ø mm
	100 42	12	weißes Ziegenhaar  white goat hair	weich soft	42
	100 48	12		weich soft	48
	100 51	12		weich soft	51
	121 36	12	schwarze Chungking Borsten	hart hard	36
	121 42	12		hart hard	42
	121 48	12	black Chung King Bristles	hart hard	48
	121 51	12		hart hard	51

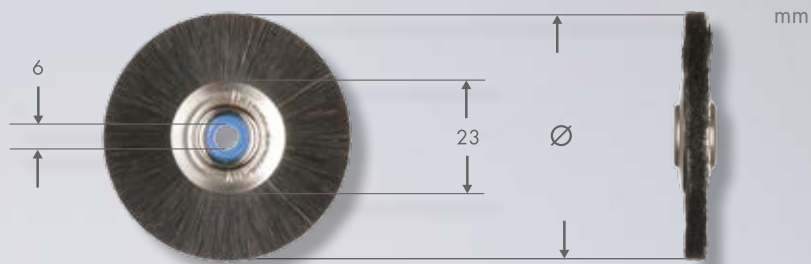

	Art.Nr. art.No.	VE PU	Besatzmaterial filling material	Charakter character	Ø mm
	150 51	12	<b>Baumwollfaden</b> cotton thread	weich soft	51
	508 51	12	<b>Wildleder</b> chamois leather	weich soft	51
	520 51	12	<b>Microfaser - Leder</b> microfiber - leather	weich soft	51
<b>COSIMA soft</b>		12	<b>Weiches silikonisiertes Baumwollgewebe</b>  soft silicon coated cotton fabric	weich soft	51
869 51			<b>silikonisiertes Baumwollgewebe</b>  silicon coated cotton fabric	hart hard	
<b>COSIMA</b>	870 51	12			51
<b>Slimline Bürsten mit Einlagen</b> Slimline brushes with insert					
	100/520 51	12	<b>weißes Ziegenhaar</b> Mikrofaser-Leder white goat hair Microfiber-leather	weich soft	51
	121 48 VL	12	<b>schwarze Chungking Borsten</b> Scotch Brite™ Einlage black Chung King bristles Scotch Brite™ insert	hart hard	48
	121 48 NE	12	<b>schwarze Chungking Borsten</b> Nesselstoff Einlage black Chung King bristles muslin insert	hart hard	48



## Minipolierbürsten

Pico Plus, Micro, Miniatur, GEZA, TORO, Kombi, ASTRO

### Mini Polishing Brushes

Pico Plus, Micro, Miniature, GEZA, TORO, Kombi, ASTRO









Das Minipolierbürsten-Programm umfasst eine Vielzahl von Bürsten mit den verschiedensten Besatzmaterialien. Ob montiert mit einem Handstückschaft oder unmontiert mit einem speziellen Reduzierstück (RED), sie sind das optimale Polierwerkzeug für die filigrane Feinpolitur am Arbeitsplatz. Angefangen mit den Pico Plus Bürsten (Ø 10 mm), über die Micro Bürsten (Ø 12, 14 mm) bis zu den Miniaturbürsten (Ø 16, 19, 22 mm) decken die Minipolierbürsten alle gängigen Arbeitsteildurchmesser ab.

Als Besonderheiten gelten die gezahnten GEZA-Bürsten und die auf rostsicheren ISO-Schäften montierten TORO-Bürsten.

Alle Anwendungsbereiche können mit den HATHO Minipolierbürsten abgedeckt werden.

HATHO Mini Polishing brushes are available in an extensive range of different filling materials. Choose from brushes mounted on a shank 2.34 mm (3/32") or, without a shank, but featuring an arbor hole of 1.8 mm (0.07"). The line starts with Pico Plus Brushes, 10 mm (0.39") in diameter, ranges through Micro Brushes, 12 and 14 mm (0.47", 9/16") in diameter and Miniatur Brushes 16, 19 and 22 mm (0.63" 3/4", 7/8") in diameter. Special Mini Polishing brush designs include the GEZA brushes and the TORO brushes that are mounted on an ISO standard stainless steel shank. Mini Polishing brushes cover all dental applications.



	Art.Nr. art.No.	VE PU	Besatzmaterial filling material	Ø mm	T mm	S mm
	100 10 PP	12/144	weißes Ziegenhaar weich	10	2,3	38
	100 12 HP	12/144		12	2,3	32,5
	100 14 HP	12/144		14	3,3	32,5
	100 16 HP	12/144		16	3	41
	100 19 HP	12/144		19	4,5	41
	100 22 HP	12/144		22	6	41
	100 16 RED	12/144	white goat hair soft	16	3	
	100 19 RED	12/144		19	4,5	
	100 22 RED	12/144		22	6	





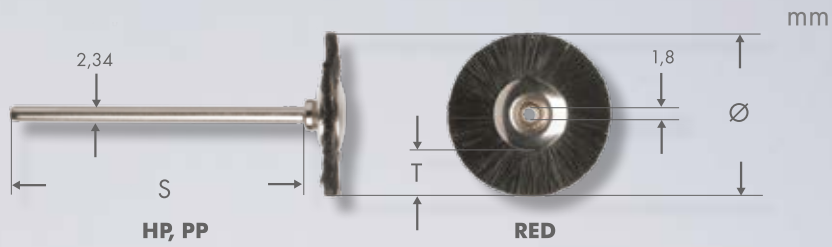

- Pico Plus
- Micro
- Miniature

	Art.Nr. art.No.	VE PU	Besatzmaterial filling material	Ø mm	T mm	S mm	
	115 10 PP	12/144	silbergraues Pferdehaar mittel	10	2,3	38	
	115 12 HP	12/144		12	2,3	32,5	
	115 14 HP	12/144		14	3,3	32,5	
	115 16 HP	12/144		16	3	41	
	115 19 HP	12/144		19	4,5	41	
	115 22 HP	12/144		22	6	41	
	115 16 RED	12/144	silver grey horse hair medium	16	3		
	115 19 RED	12/144		19	4,5		
	115 22 RED	12/144		22	6		
	121 10 PP	12/144		schwarze Chungking Borsten hart	10	2,3	38
	121 12 HP	12/144			12	2,3	32,5
	121 14 HP	12/144			14	3,3	32,5
121 16 HP	12/144	16	3		41		
121 19 HP	12/144	19	4,5		41		
121 22 HP	12/144	22	6		41		
121 16 RED	12/144	black Chung King bristles hard	16	3			
121 19 RED	12/144		19	4,5			
121 22 RED	12/144		22	6			



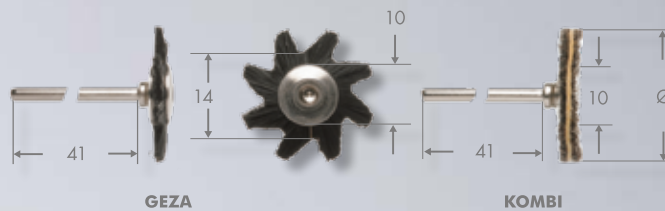
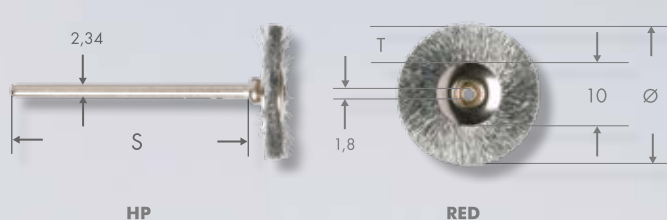

	Art.Nr. art.No.	VE PU	Besatzmaterial filling material	Ø mm	T mm	S mm	
	143 14 HP	12/144	<b>Micro</b> Messingdraht gewellt	14	3,3	32,5	
	143 16 HP	12/144		16	3	41	
	143 19 HP	12/144		19	4,5	41	
	143 16 RED	12/144		16	3		
	143 19 RED	12/144		19	4,5		
		193 14 HP	12/144	<b>Miniature</b> Micro Stahldraht gewellt	14	3,3	32,5
		193 16 HP	12/144		16	3	41
		193 19 HP	12/144		19	4,5	41
		193 16 RED	12/144		16	3	
		193 19 RED	12/144		19	4,5	

	Art.Nr. art.No.	VE PU	Besatzmaterial filling material	Ø mm	T mm	
	GEZA 100 HP	12/144	weißes Ziegenhaar, extra weich white goat hair, extra soft	22	6	
	GEZA 115 HP	12/144	silbergraues Pferdehaar, standard hart silver grey horse hair, standard hard	22	6	
	GEZA 121 HP	12/144	schwarze Chungking Borsten, hart black Chung King bristles, hard	22	6	
	<b>KOMBI</b>					
	100/520 22 HP	12/144	weißes Ziegenhaar / Mikrofaser-Leder white goat hair / Microfiber-leather	22	6	
	102/520 22 HP	12/144	graues Ziegenhaar / Mikrofaser-Leder grey goat hair / Microfiber-leather	22	6	
	100/862 22 HP	12/144	weißes Ziegenhaar / ZETA Tuch white goat hair / ZETA cloth	22	6	
	102/862 22 HP	12/144	graues Ziegenhaar / ZETA Tuch grey goat hair / ZETA cloth	22	6	
	ScoCo 120/252 22 HP	12/144	weiße Borsten / rotes Scotch Brite white bristles / red scotch brite	22	6	
	ScoCo 120/253 22 HP	12	weiße Borsten / weißes Scotch Brite white bristles / white scotch brite	22	6	





ISO Standard Schaft  
ISO Standard shank



	Art.Nr. art.No.	VE PU	Besatzmaterial filling material	Ø mm	T mm
	TORO 3 100	144	weißes Ziegenhaar, extra weich white goat hair, extra soft	14,4	2,8
	TORO 5 100	144		17,5	3,8
	TORO 7 100	144		19	4,6
	TORO 3 102	144	graues Ziegenhaar, weich grey goat hair, soft	14,4	2,8
	TORO 5 102	144		17,5	3,8
	TORO 7 102	144		19	4,6
	TORO 3 115	144	silbergraues Pferdehaar, standard hart silver grey horse hair, standard hard	14,4	2,8
	TORO 5 115	144		17,5	3,8
	TORO 7 115	144		19	4,6
	TORO 3 114	144	schwarzes Pferdehaar, extra hart black horse hair, extra hard	14,4	2,8
	TORO 5 114	144		17,5	3,8
	TORO 7 114	144		19	4,6
	ASTRO 7 100	144	weißes Ziegenhaar, extra weich white goat hair, extra soft	19	4,6
	ASTRO 9 100	144		22	4,6
	ASTRO 7 102	144	graues Ziegenhaar, weich grey goat hair, soft	19	4,6
	ASTRO 9 102	144		22	4,6
	ASTRO 7 115	144	silbergraues Pferdehaar, standard hart silver grey horse hair, standard hard	19	4,6
	ASTRO 9 115	144		22	4,6
	ASTRO 7 114	144	schwarzes Pferdehaar, extra hart black horse hair, extra hard	19	4,6
	ASTRO 9 114	144		22	4,6

## Minipinselbürsten Mini End Brushes



Weiches Ziegenhaar, mittelhartes Pferdehaar, harte Chungking Borsten, fein gewellter Stahl- oder Messingdraht, sowie feiner Baumwollzwirn sind die ausgewählten Besatzmaterialien für das Sortiment an HATHO Minipinselbürsten. Die besondere Formgestaltung der HATHO Minipinselbürsten ermöglicht das Polieren von schwer zugänglichen, innenliegenden Flächen bei Teleskopkronen, Konuskronen und Ankerarbeiten. Mit einem Arbeitsteildurchmesser von 3 oder 5 mm können die HATHO Minipinselbürsten die engen Innenflächen von Unterkiefer-Konuskronen mühelos polieren.

Soft goat hair, medium horsehair, hard Chung King bristles, fine crimped steel, brass wire and fine cotton thread are the selected filling materials within the HATHO Mini End brush line. The specially designed shape allows polishing of difficult to reach or inner areas of telescope crowns, tapered crowns and attachments. With a brush head diameter of 3 or 5 mm (0.12" or 0.20"), HATHO Mini End brushes are produced to polish the narrowest of areas, such as the inner parts of a lower jaw tapered crown.





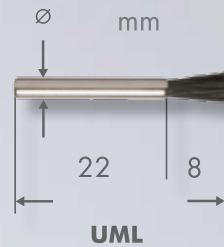
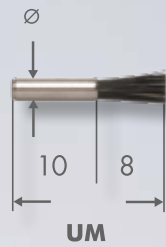
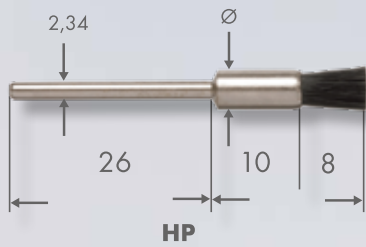

Für UM + UML  
Mandrel SP 3 HP  
(S.43) verwenden!

Use for UM or UML  
Mandrel SP 3 HP!  
(p.43)



	Art.Nr. art.No.	VE PU	Besatzmaterial filling material	Ø mm
	100 p8 HP	12	weißes Ziegenhaar white goat hair	5
	115 p8 HP	12	graues Pferdehaar grey horse hair	5
	121 p8 HP	12	schwarze Chungking Borsten black Chung King bristles	5
	150 p8 HP	12	Baumwollzwirn cotton thread	5
	143 p8 HP	12	Messingdraht, gewellt crimped brass wire	5
	193 p8 HP	12	Stahldraht, gewellt crimped steel wire	5
	100 p6 UM	12	weißes Ziegenhaar white goat hair	3
	115 p6 UM	12	graues Pferdehaar grey horse hair	3
	121 p6 UM	12	schwarze Chungking Borsten black Chung King bristles	3
	143 p6 UM	12	Messingdraht, gewellt crimped brass wire	3
	193 p6 UM	12	Stahldraht, gewellt crimped steel wire	3
	100 p6 UML	12	weißes Ziegenhaar white goat hair	3
	115 p6 UML	12	graues Pferdehaar grey horse hair	3
	121 p6 UML	12	schwarze Chungking Borsten black Chung King bristles	3
	143 p6 UML	12	Messingdraht, gewellt crimped brass wire	3
	193 p6 UML	12	Stahldraht, gewellt crimped steel wire	3



# Schleifvliesräder

## Abrasive Trimming Wheels

Die HATHO Schleifvliesräder aus qualitativ hochwertigem 3M Scotch Brite™ werden auf die konische Spindel des Poliermotors aufgespannt. Die zwei oder vier Lagen Schleifvlies werden durch das patentierte Brechflanschsystem seitlich stabilisiert. Das erlaubt eine Verringerung der Umdrehungszahl und führt zu einer längeren Lebensdauer. Mit den HATHO Schleifvliesrädern werden die Ränder und großflächige Teile von Abdrucklöffeln aus selbst- und lichterhärtenden Kunststoffen geglättet. Auch beim Mundschutz und Tiefziehschienen werden die Ränder mit den Schleifvliesrädern effektiv bearbeitet.

HATHO Abrasive Trimming Wheels constructed with high quality 3M Scotch Brite™ material are used on the conical spindle of a polishing unit. The abrasive wheels, consisting of either two or four layers, are stabilized by the HATHO patented removable ring system. This tool permits for a work process at a reduced rpm, greatly increasing the life span of the discs. HATHO Abrasive Trimming Wheels are used for smoothing borders and large surface areas, like that of base plates and trays made of light cure and self-cure resin. Mouth guards and splints from thermoplastics can also be easily trimmed with our abrasive trimming wheels.



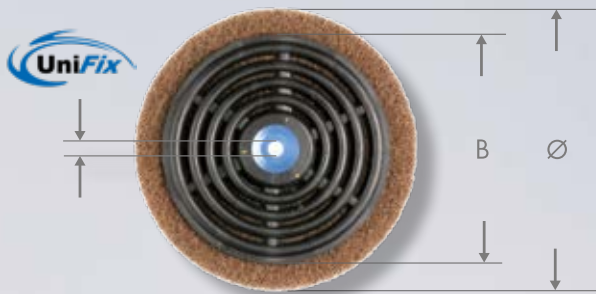

	Art.Nr. art.No.	VE PU	Schleifkorn grit	Charakter character	Ø mm	B mm	Lagenzahl layers
	250 110 VL/2	1	AO	grob coarse	110	90	2
	250 110 VL/4	1	AO		110	90	4
	250 80 VL/2	1	AO		80	63	2
	250 80 VL/4	1	AO		80	63	4
	251 110 VL/2	1	SIC	mittel medium	110	90	2
	251 110 VL/4	1	SIC		110	90	4
	251 80 VL/2	1	SIC		80	63	2
	251 80 VL/4	1	SIC		80	63	4
	255 110 VL/2	1	AO	fein fine	110	90	2
	255 110 VL/4	1	AO		110	90	4
	255 80 VL/2	1	AO		80	63	2
	255 80 VL/4	1	AO		80	63	4





## Minischleifvliesräder Mini Trimming Wheels

Die HATHO Minischleifvliesräder aus qualitativ hochwertigem 3M Scotch Brite™ sind der optimale Ersatz für die Schmirgelpapieranwendungen. Die doppellagige, genietete Ausführung der HATHO Minischleifräder gewährleistet eine überraschende Standzeit ohne Materialverlust durch Rundlaufungenauigkeiten. Die Anwendungsgebiete sind die Oberflächenbearbeitung von weichbleibenden Unterfütterungen, Mundprotektoren, Tiefziehfolien, individuellen Abdrucklöffeln, Kunststoffprothesen, Komposit-Verblendkronen usw., bis hin zum Satinieren von filigran ausgearbeiteten Edelmetallkaufächen. Eine Besonderheit ist das gepresste TrimSoft Rad für das zügige Ausarbeiten von weichbleibenden Unterfütterungen und Prothesen aus thermoplastischem Nylon.

HATHO Mini Abrasive Fiber Wheels manufactured from high quality 3M Scotch Brite™ are the best alternative to emery-paper. The two layer design has a surprisingly long lifespan with no loss of material due to circular inaccuracies. Application versatility includes: surface treatment of soft liner acrylics, mouth guards, thermoforming foils and plates, individual impression trays, denture acrylics, composite veneers, etc. up to filigree ground precious metal of occlusal surfaces. A special feature of this group is the TrimSoft wheel used for fast grinding of soft liner acrylics and thermoplastic Nylon.





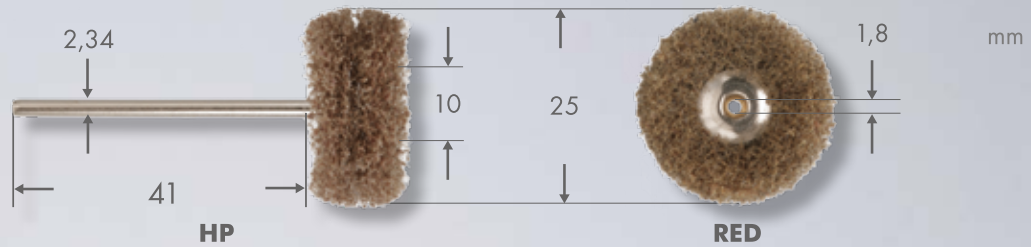

	Art.Nr. art.No.	VE PU	Schleifkorn grit mesh	Charakter character	Farbe color
	250 25 HP	12	AO <b>220</b>	<b>grob</b> coarse	<b>Braun</b> Brown
	251 25 HP	12	SIC <b>280</b>	<b>mittel</b> medium	<b>Grau</b> Grey
	255 25 HP	12	AO <b>360</b>	<b>fein</b> fine	<b>Purpur</b> Purple
	257 25 HP	12	SIC <b>400</b>	<b>extra fein</b> extra fine	<b>Hellgrau</b> Light Grey
	256 25 HP	12	AO <b>600</b>	<b>ultra fein</b> ultra fine	<b>Kupfer</b> Copper
	253 25 HP	12	—	<b>ohne Schleifmittel</b> without abrasive	<b>Weiß</b> White
	250 25 RED	12	AO <b>220</b>	<b>grob</b> coarse	<b>Braun</b> Brown
	251 25 RED	12	SIC <b>280</b>	<b>mittel</b> medium	<b>Grau</b> Grey
	255 25 RED	12	AO <b>360</b>	<b>fein</b> fine	<b>Purpur</b> Purple
	257 25 RED	12	SIC <b>400</b>	<b>extra fein</b> extra fine	<b>Hellgrau</b> Light Grey
	256 25 RED	12	AO <b>600</b>	<b>ultra fein</b> ultra fine	<b>Kupfer</b> Copper
	253 25 RED	12	—	<b>ohne Schleifmittel</b> without abrasive	<b>Weiß</b> White
	<b>TrimSoft</b> 240 25 R	12	AO	<b>grob</b> coarse	<b>3 mm gepresst</b> 3 mm pressed



## Polierschwabbeln Polishing Buffs

Das HATHO Polierschwabbelprogramm ist in seiner Materialvielfalt kaum zu überbieten. Von Nesselstoff über Flanelltuch bis zu Mikrofaser-Leder und ZETA-Tuch findet jede Anwendung die geeignete Polierschwabbel für die Glanz- und Hochglanzpolitur. Der HATHO UniFix-Kern (Info Seite 5) sorgt für ein Zentrieren auf der konischen Spindel des Poliermotors und gibt der Schwabbel einen perfekten Rundlauf. Die Polierschwabbeln mit patentiertem Brechflansch zeichnen sich durch eine maximale laterale und frontale Stabilität aus. Alle Dentalmaterialien können mit den HATHO Polierschwabbeln auf Hochglanz poliert werden.

HATHO Polishing Buffs are offered with an extensive range of filling materials, amongst a few: muslin, flannel, microfiber-leather and ZETA-cloth. There is an ideal buff for every possible dental polishing or shining procedure. The unique design of HATHO's UniFix center guarantees that the buff is centered on a conical spindle ensuring perfect rotation. HATHO also offers a unique, patented removable ring design to ensure lateral stability. With HATHO buffs, all dental materials can be polished to a high shine.







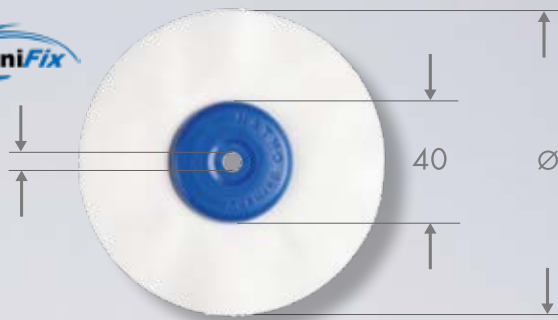





	Art.Nr. art.No.	VE PU	Material material	Ø mm	B mm	F mm	Lagenzahl layers
	160 110 NE/30	1	Nesselstoff	110	90	18	30
	160 110 NE/45	1		110	90	20	45
	160 80 NE/30	1	muslin	80	63	18	30
	160 80 NE/45	1		80	63	20	45
	162 110 FI/12	1	Filztuch	110	90	28	12
	162 110 FI/6	1		110	90	18	6
	162 80 FI/12	1	felt cloth	80	63	28	12
	162 80 FI/6	1		80	63	18	6
	500 110 CH/12	1	Wildleder	110	90	23	12
	500 110 CH/6	1		110	90	18	6
	500 80 CH/12	1	chamois leather	80	63	23	12
	500 80 CH/6	1		80	63	18	6
	520 110 CH/12	1	Microfaser- Leder	110	90	19	12
	520 110 CH/6	1		110	90	16	6
	520 80 CH/12	1	microfiber- leather	80	63	19	12
	520 80 CH/6	1		80	63	16	6













mm

	Art.Nr. art.No.	VE PU	Material material	Ø mm	F mm	Lagenzahl layers
	161 100/20	1	<b>Flanell</b> flannel	100	17	20
	162 100/6	1	<b>Filztuch</b> felt cloth	100	18	6
	164 100/20	1	<b>gebleichter Nesselstoff</b> bleached muslin	100	15	20
	164 100/40	1	<b>gebleichter Nesselstoff</b> bleached muslin	100	18	40
	508 100/7	1	<b>Wildleder</b> chamois leather	100	16	7
	520 100/7	1	<b>Mikrofaser- Leder</b> microfiber- leather	100	15	7
	862 100/15	1	<b>ZETA Tuch</b> ZETA cloth	100	15	15
	869 100/14	1	<b>COSIMA soft</b> Weiches silikoniertes Baumwollgewebe Soft Silicon Coated Cotton fabric	100	10	14
	870 100/14	1	<b>COSIMA</b> silikoniertes Baumwollgewebe Silicon Coated Cotton fabric	100	12	14





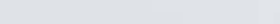

	Art.Nr. art.No.	VE PU	Material material	Ø mm	B mm	F mm
	152 80 BW	1	Baumwoll- mullen cotton buffs	80	40	18
	156 80/4 HS	1		80	40	27
	156 80/6 HS	1		80	40	37
	156 80 H	1		80	33	23
	156 100 H	1		100	43	23
	500 80 LE	1	Wildleder chamois leather	80	40	18
	520 90 LE	1	Mikrofaser- Leder Microfiber- leather	90	40	18
<b>MIRA Schwabbel MIRA Buff</b>						
	867 4" x 50 HG	1	versteifter Nesselstoff	100	35	13
	867 5" x 50 HG	1	treated muslin	125	35	13
	868 4" x 50 HG	1	gebleichter Nesselstoff bleached muslin	100	35	13
	868 5" x 50 HG	1		125	35	13
	868 4" x 50 H	1		100	35	13

# Minipolierschwabbeln

## Mini Polishing Buffs

Die Vielfalt der verwendeten Materialien für die HATHO Minipolierschwabbeln lässt keine Wünsche mehr offen. Wie bei den großen Polierschwabbeln werden Baumwollzwirn, Leder, Nesseltuch, Flanell, Filztuch, Mikrofaser-Leder und ZETA-Tuch eingesetzt. Alle Dentalmaterialien können mit den HATHO Minipolierschwabbeln auf Hochglanz poliert werden. Eine Besonderheit ist das neue ZETA-Tuch. Es verliert keine einzelnen Stofffäden, wie gewobener Stoff, und arbeitet sich gleichmäßig ab.

With an extensive Mini Polishing Buff product range, HATHO Buffs meet every possible polishing desire. Just as with large buffs the Mini Polishing Buffs are manufactured from cotton thread, muslin, flannel, felt, microfiber-leather and our special ZETA cloth. Every conceivable dental material is brought to a high and lustrous shine when polished with HATHO Mini Polishing Buffs. One of our newest specialties is our ZETA cloth, which, as compared to conventional cloth, does not shed individual threads but wears evenly.



	Art.Nr. art.No.	VE PU	Besatzmaterial filling material	Charakter charakter
	150 22 HP	12/144	grober Baumwollfaden	normal voll normal full
	150 22 RED	12/144		
	151 22 HP	12/144	coarse cotton thread	normal voll normal full
	151 22 RED	12/144		
	152 22 HP	12/144	feiner Baumwollfaden	doppel voll double full
	153 22 HP	12/144		
	154 22 HP	12/144	fine cotton thread	extra voll extra full
	155 22 HP	12/144		

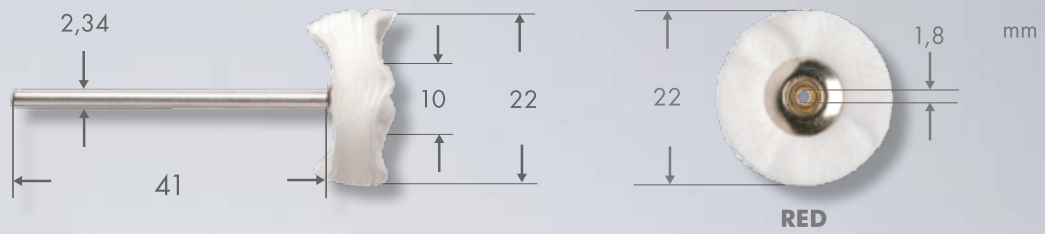

	Art.Nr. art.No.	VE PU	Besatzmaterial filling material	Charakter charakter	Lagenzahl layers
	161 22 HP	12/144	Flaneltuch flannel cloth		8
	161 22 RED	12/144			
	162 22 HP	12/144	Filztuch felt cloth		3
	162 22 RED	12/144			
	160 22 g HP	12/144	Nesseltuch muslin cloth	genäht oder ungenäht stitched or not stitched	16
	160 22 HP	12/144			
	160 22 RED	12/144			
	520 22 HP	12/144	Mikrofaser-Leder microfiber-leather		5
	520 22 RED	12/144			
	500 22 HP	12/144	Ziegenleder goat skin		5
	500 22 RED	12/144			
	862 22 HP	12/144	ZETA Tuch ZETA cloth		10
	862 22 RED	12/144			
	869 22 HP	12/144	COSIMA soft COSIMA soft		8
	869 22 RED	12/144			
	870 22 HP	12/144	COSIMA COSIMA		5
	870 22 RED	12/144			



## HATHOfex S plus P

### HATHOfex S plus P





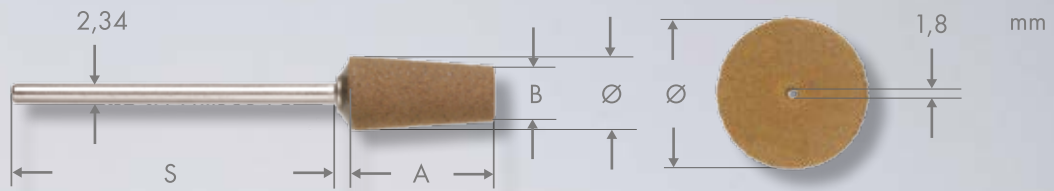

Die HATHOfex S plus P Schleif- und Polierwerkzeuge bestehen aus zähelastisch gebundenem Korund. Das gleichzeitige Abtragen und Polieren schafft eine günstige Ausgangsbasis für die Schlusspolitur. Durch hochtouriges Arbeiten und geringen Anpressdruck werden die besten Ergebnisse erzielt und die maximale Standzeit erreicht. Modellgussarbeiten aus CrCo, Nichtedelmetallgerüste und Suprastrukturen aus Titan, sowie thermoplastisches Nylon, werden vorzugsweise mit HATHOfex S plus P vorpoliert.

The HATHOfex S plus P grinding and polishing tools are made with tough elastic bonded corundum. Simultaneously removing and polishing materials prepares surface areas for final polishing. Working with a high rpm and little pressure ensures best results and maximum longevity of the tool. Framework of CrCo, non precious crown and bridge work, supra structures of titanium as well as thermoplastic nylon can be pre-polished by HATHOfex S plus P.







	Art.Nr. art.No.	VE PU	Korngröße grit size	S mm	A mm	Ø mm	B mm
	204 20 R	12	80	..	3	20	..
	204 20 HP	4	80	41	3	20	..
	202 6 HP	4	80	36	16	6	..
	202 8 HP	4	80	36	16	8	..
	200 6 HP	4	80	38	15	6	1
	205 17 HP	4	80	31	3	17	..
	206 8 HP	4	80	36	16	12	8



## DiaStone, DiaDisc

### DiaStone, DiaDisc

Das eingearbeitete Schleif- und Poliermittel in der HATHO DiaStone und DiaDisc Serie ist Diamant. Dieses härteste Mineral der Erde wird sorgfältig feingesiebt, um dadurch die Toleranzen der Diamantkorngrößen zu minimieren. Die keramisch gebundenen DiaStones zeichnen sich durch ihre Rundlaufgenauigkeit, ihre Langlebigkeit und ihre effektive Schleifleistung aus.

Die hauchdünnen DiaDiscs weisen hohe Flexibilität und metallfreie Bindung auf. Die Materialien Zirkonoxid, Dentalkeramik und Verblendkomposite werden spielend leicht mit den DiaStones ausgearbeitet und mit den DiaDiscs interdental poliert. Die extrafeinen DiaStones (gelb) eignen sich hervorragend zur Vorpolitur von Zirkon oder  $\text{LiSi}_2$ , vor dem hochglanzpolieren mit Polistar Pro Diamant.

The grinding and polishing material within the DiaStones and the DiaDiscs is diamond. The hardest mineral in the world is sieved with an accuracy allowing for minimal diamond size distribution in the DiaStones. The ceramic bonded DiaStones are distinguished by their rotation accuracy, long life span and their effective grinding performance.

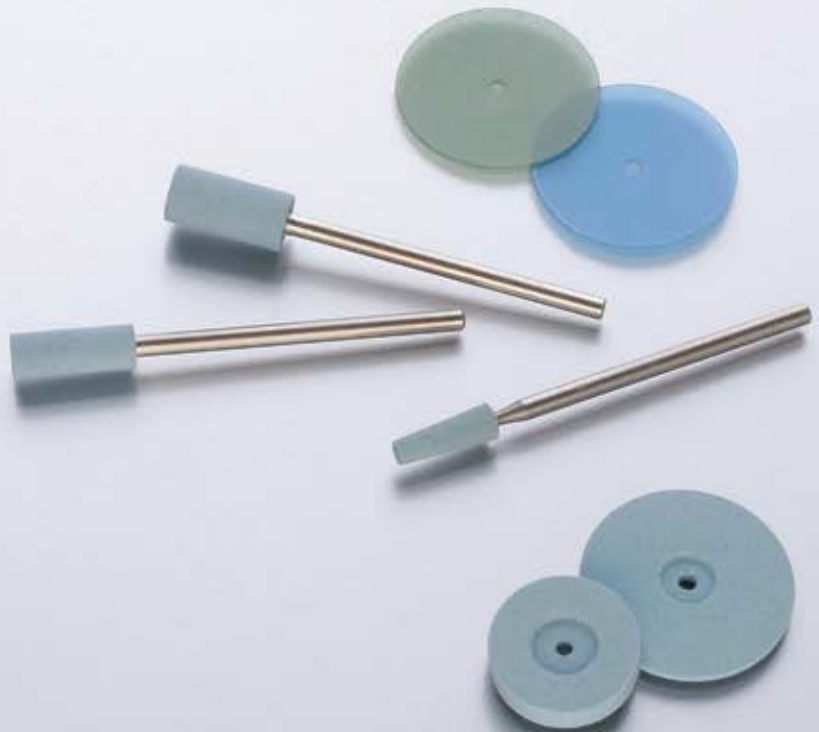

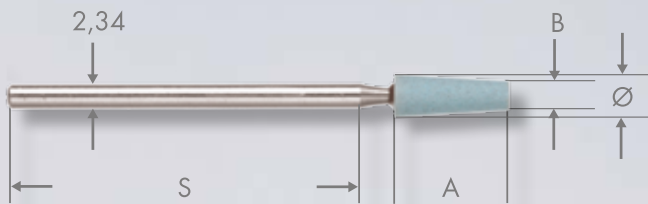

DiaStone

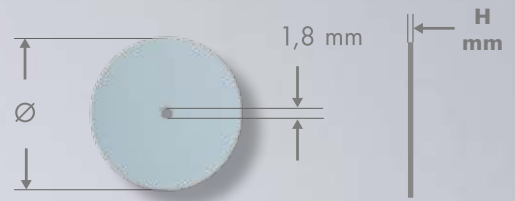

DiaDisc

DiaStone\_Z, DiaStone\_L

	Art.Nr. art.No.	Farbe color	Anwendung application	Korngröße grit size	S mm	A mm	Ø mm	B mm				
 10.000	327 4 HP	■	L	extra fein extra fine	800	33	11	4				
	367 4 HP	■	Z									
	337 4 HP	■	L	mittel medium					200			
	377 4 HP <sup>+</sup>	■	Z									
	387 4 HP	■	L	grob coarse						120		
397 4 HP <sup>+</sup>	■	Z										
322 4 HP	■	L	extra fein extra fine	800	34	12	4					
362 4 HP	■	Z										
332 4 HP	■	L	mittel medium					200				
372 4 HP <sup>+</sup>	■	Z										
382 4 HP	■	L	grob coarse						120			
392 4 HP	■	Z										
332 6 HP	■	L	mittel medium	200	34	12	6					
372 6 HP <sup>+</sup>	■	Z										
382 6 HP	■	L	grob coarse					120				
392 6 HP <sup>+</sup>	■	Z										
371 5 HP	■	Z	mittel medium						200	33		5
334 15 HP	■	L	mittel medium	200	40	3	15					
374 15 HP <sup>+</sup>	■	Z										
334 15 R	■	L										
374 15 R	■	Z										
335 22 HP	■	L						mittel medium	200	40	3	22
375 22 HP	■	Z										
335 22 R	■	L										
375 22 R	■	Z										

+ HP.B lieferbar  
+ HP.B deliverable

**Z** empfohlen für ZrO<sub>2</sub>-Keramik  
recommended for ZrO<sub>2</sub> Ceramic

**L** empfohlen für LiSi<sub>3</sub>, Hybridkeramik  
recommended for LiSi<sub>3</sub>, Hybrid ceramics

DiaDisc

				Ø mm	H mm
	343 22 R	Blau blue	extra fein extra fine	22	0,5
	346 22 R	Grün green	fein fine		

## Polierfilze Felt Polishers

Die HATHO Filzpolierkörper sind ideale Träger für Poliermittel aller Art. Besonders das feine Diamantkorn setzt sich gut in den verwinkelten Strukturen der gewalkten Schafswolle fest. Die verwendeten Filzhärten und -dichten verleihen den HATHO Filzpolierern eine hohe Kantenstabilität. Je nach eingesetzter Polierpaste können Prothesenkunststoffe, Komposite, Edel- und Nichtedelmetalllegierungen bis hin zu Titan effektiv mit Filzpolierkörpern auf Hochglanz poliert werden.

HATHO felt polishers are excellent carriers of different polishing compounds. Fine diamond abrasive particles attach perfectly to the open structure of the densely filled natural sheep's wool. The durability and density of the felt, gives the HATHO felt polishers a higher-edge stability. Depending on the selection of polishing pastes, felt polishers can be used for polishing and high shining polishing of composites, precious and non-precious metals and even titanium.





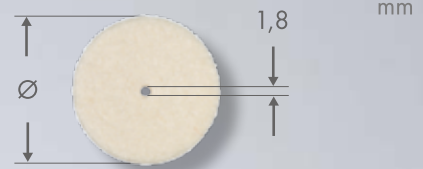
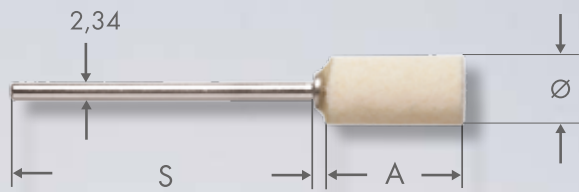

	Art.Nr. art.No.	VE PU	Charakter character	S mm	A mm	Ø mm
	174 12x3 036	12	weich soft	..	3	12
	174 25x4 028	12		..	4	25
	174 21 HP	12	hart hard	41	4	21
	175 12x3	12		..	3	12
	175 21 HP	12		41	4	21
	172 6 HP	12		36	16	6
	172 8 HP	12		36	16	8
	173 6 HP	12		36	19	6
	173 9 HP	12	36	20	9	
	173 15x25	1	weich soft	..	25	15
	173 20x40	1		..	40	20
	173 25x50	1		..	50	25

# Pasten, Emulsion Compounds, Emulsion



Das richtige Poliermittel ist entscheidend für eine erfolgreiche Politur. Um effektiv die unterschiedlichen Dentalwerkstoffe schrittweise zu polieren, werden bei den HATHO Polistar Polierpasten ausgewählte Wachse und hochwertige Mineralien miteinander kombiniert. Für eine optimale Zuordnung der Anwendungsgebiete werden den Polistar Rezepturen natürliche Farben beigemischt. Der hohe Füllgrad an Mineralien zeichnet das HATHO Polistar Sortiment aus. Als krönenden Abschluss einer erfolgreichen Hochglanzpolitur findet die Polistar Emulsion ihre Anwendung.

Using the right polishing compounds is crucial for a successful polish. For the efficient and effective polishing of dental work materials, HATHO offers its range of Polistar polishing compounds in which selected waxes and high quality minerals have been optimally combined. Selected waxes and high quality minerals are optimally combined. Polistar products are distinguished by a very high fill density of minerals. Using the liquid PoliStar Emulsion is the optimal choice for a final polish.



**Kunststoff  
acrylic**



**Thermoplast  
thermoplastic**



**Komposit  
composite**



**Modellguss  
frame work**



**Edelmetall  
precious**



**NEM  
non-precious**



**Keramik  
ceramic**



**Titan  
titanium**



**ZrO<sub>2</sub>/LiSi<sub>2</sub>  
ZrO<sub>2</sub>/ LiSi<sub>2</sub>**

Anwendung  
Application

## Vorpolitur • pre-polishing

**Polistar  
Lintygrau  
Lintygrey**



90 g

Ref.No.  
313168



280 g

Ref.No.  
313175



1,2 kg

Ref.No.  
313150



## Glanzpolitur • shine polishing

**Polistar  
Creme  
Cream**



90 g

Ref.No.  
313200



**Polistar  
Weiß  
White**



90 g

Ref.No.  
313162



290 g

Ref.No.  
313169



1,4 kg

Ref.No.  
313131



Hochglanzpolitur • high shine polishing

**Polistar**  
Grün  
Green



90 g  
Ref.No.  
313166



300 g  
Ref.No.  
313173



1,4 kg  
Ref.No.  
313132

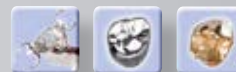

**Polistar**  
Rot  
Red



100 g  
Ref.No.  
313163



300 g  
Ref.No.  
313170



1,1 kg  
Ref.No.  
313114



**Polistar**  
Blau  
Blue



75 g  
Ref.No.  
313165



290 g  
Ref.No.  
313172



1,1 kg  
Ref.No.  
313133



**Polistar**  
Rosa  
Pink



75 g  
Ref.No.  
313164



290 g  
Ref.No.  
313171



1,1 kg  
Ref.No.  
313153



**Polistar**  
Beige  
Beige



85 g  
Ref.No.  
313167



290 g  
Ref.No.  
313174



1,2 kg  
Ref.No.  
313134

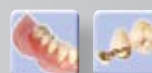

Spiegelglanz • mirror finish

**Pro Rosa**  
Pro Pink



150 g  
Ref.No.  
313196



**Pro Orange**  
Pro Orange



150 g  
Ref.No.  
313188



**Pro Blau**  
Pro Blue



150 g  
Ref.No.  
313197



Spiegelglanz • mirror finish

**Pro Diamant** 12 g  
Diamant  
Diamond



2 $\mu$ m  
Ref.No.  
313214

8g



2 $\mu$ m  
Ref.No.  
313262

4 g



3 $\mu$ m  
Ref.No.  
313081

1,5 g



3 $\mu$ m  
Ref.No.  
313085



Finale Politur • final polishing

**Emulsion**  
Emulsion



125 ml  
Ref.No.  
313139



50 ml  
Ref.No.  
313148

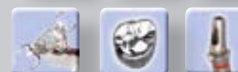

# Keramikpinsel

## Ceramic Brushes

Hochwertige Keramikpinsel sind des Keramikers bevorzugtes Werkzeug beim Modellieren von natürlichen Zahnformen aus Dentalkeramik. Die Tamara-Mustela Haarpinsel zeichnen sich durch ihre bauchige Pinselform, ihre feine stabile Spitze und ihre besondere Fähigkeit Wasser aufzunehmen aus. Der dreieckige Handgriff verhindert das Wegrollen und liegt ergonomisch zwischen den Fingern. Die Murena-Sable Serie wird aus ausgewähltem Zobelfeinhaar hergestellt. Die torpedoförmige Pinselform und die hohe Flexibilität der Haare sind ihr Markenzeichen. Für das Auftragen der Opaker Massen eignen sich die flachen Pinselformen der Samyra-Zobel Ausführungen.

High quality dental ceramics brushes are ceramists favored tools for modeling ceramic teeth. The Tamara-Mustela (weasel) hair brushes, distinguished by their bulky shape and their fine, stable tip, have a special ability to absorb water. The Murena-Sable hair brush is manufactured of selected sable hair. Its special characteristics are the torpedo - shaped tip and the high flexibility of the hair. The third type is the Samyra-Sable hair brush. With their flat shape these products are suited for the application of opaque masses.







1:1	Art.Nr. art.No.	ID.Nr. ref. No.	Größe size	Charakter character
	Tamara-Mustela-Pinsel 00 Tamara-Mustela-Brush 00	TK 00	00	<p>Feinstes Wieselhaar, bauchiges Haarbündel, feine stabile Pinselspitze, dreieckiger Handgriff.</p> <p>Finest weasel hair, bulky hair bundle, thin stable tip, triangular handle.</p>
	Tamara-Mustela-Pinsel 0 Tamara-Mustela-Brush 0	TK 0	0	
	Tamara-Mustela-Pinsel 2 Tamara-Mustela-Brush 2	TK 2	2	
	Tamara-Mustela-Pinsel 4 Tamara-Mustela-Brush 4	TK 4	4	
	Tamara-Mustela-Pinsel 6 Tamara-Mustela-Brush 6	TK 6	6	
	Tamara-Mustela-Pinsel 8 Tamara-Mustela-Brush 8	TK 8	8	
	Murena-Zobel-Pinsel 00 Murena-Sable-Brush 00	MZ 00	00	<p>Feinstes Zobelhaar, kegeliges Haarbündel, flexible Pinselspitze, runder Handgriff.</p> <p>Finest sable hair, Tapered hair bundle, thin flexible tip, round handle.</p>
	Murena-Zobel-Pinsel 0 Murena-Sable-Brush 0	MZ 0	0	
	Murena-Zobel-Pinsel 2 Murena-Sable-Brush 2	MZ 2	2	
	Murena-Zobel-Pinsel 4 Murena-Sable-Brush 4	MZ 4	4	
	Murena-Zobel-Pinsel 6 Murena-Sable-Brush 6	MZ 6	6	
	Murena-Zobel-Pinsel 8 Murena-Sable-Brush 8	MZ 8	8	
	Samyra-Zobel-Pinsel 0 Samyra-Sable-Brush 0	SP 0	0	<p>Feinstes Zobelhaar, flaches Haarbündel, runder Handgriff.</p> <p>Finest sable hair, flat hair bundle, round handle.</p>
	Samyra-Zobel-Pinsel 02 Samyra-Sable-Brush 02	SP 02	02	

# FiberDisc Faserverstärkte Trennscheiben Reinforced Fiber Discs



Info



Ø 40 mm = 5.000 rpm  
 Ø 25 mm = 10.000 rpm  
 Ø 22 mm = 15.000 rpm  
 Ø 20 mm = 15.000 rpm

**Für Metall mit Aluminium Oxide**  
For metal with aluminum oxide

Art.Nr. art.No.	Ø mm	B mm
654 22x02 H	22	0,2
654 22x03 H	22	0,3
654 22x05 H	22	0,5
654 25x02 H	25	0,2
654 25x03 H	25	0,3
654 25x05 H	25	0,5
654 40x05 H	40	0,5
654 40x07 H	40	0,7
654 40x10 H	40	1,0

10

**Für Keramik mit Siliziumkarbid**  
For ceramic with silicon carbide

754 22x02 H	22	0,2
754 22x03 H	22	0,3
754 25x02 H	25	0,2
754 25x03 H	25	0,3

10

**Für Keramik und Zirkon mit Diamant**  
For ceramic and zirconium with diamond

854 20x02 H	20	0,2
854 20x03 H	20	0,3

1

# Mandrels, Handwerkzeuge Mandrels, Hand Tools

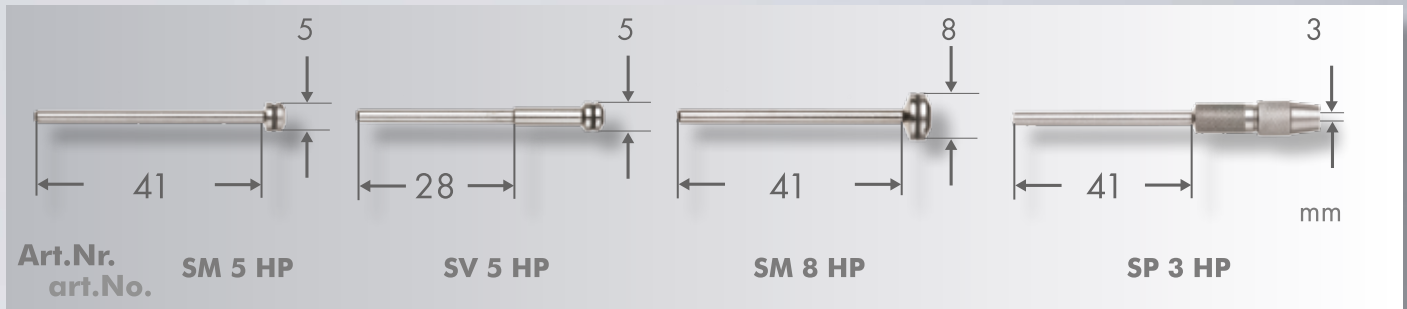

Art.Nr. art.No.	Einsatz application
630 00	Mattierstylo mit Glasfasereinsatz glass fiber matting handle
630 01	Glasfasereinsatz glass fiber refill
642 00	Stahlbohrerreiniger mit glattem Messingdraht steel bur cleaner with straight brass wire
642 01	Messingdrahteinsatz brass wire refill
682 00	Diamantschleiferreiniger mit glattem V2A Stahldraht diamond bur cleaner with straight V2A steel wire
682 01	V2A Stahldrahteinsatz V2A steel refill
143 60 NI	Reinigungsbürste mit Schieblasche, gewellter Messingdraht scrubbing brush with grafter, crimped brass wire
143 KB 40	Kratzbürste starr, gewellter Messingdraht fixed slide brush, crimped brass wire

## FILIO Adapterspindeln FILIO bur chuck



z.B. für Poliermotoren der Firmen

Reitel, Schütz, FARO, Gamberini

i.e. for spindles of polishing units from

KAVO, Degussa, Schuler

Wassermann, Leleux

# Poliersets Polishing Kits



## CeroPol Set

Ref. Nr. 313087

Politur Sortiment mit Diamantpaste und Kombibürsten für die rationelle Hochglanzpolitur von Metalllegierungen (edel und unedel), Keramiken, Kompositen und Titan

Polishing assortment including diamond paste and Kombi brushes for high shine polishing of all metals (precious and non-precious), ceramics, composites and titanium.

Inhalt, contents:

1x Polistar Diamant 4 g / 3x 100/500 22 HP / 3x 102/500 22 HP



## 3D MaxiPol Set

Ref.No. 313240

Set zum Polieren von Dental-Prothesen- und 3D- Kunststoffen am Poliermotor. Ideale Vorpolitur mit der Einlagebürste 4280 und der Polistar Lintygrau. Glanzpolitur mit der Microfaserlederschwabbel und der Polistar Beige. Perfekter Hochglanz mit der Baumwollmulle und der Polistar Emulsion.

Set of products to polish acrylic dentures and 3D -resins on the polishing lathe. Perfect pre-polishing with the Poly-buff brush 4280 and Polistar Lintygrey. Shine polishing with the microfiber leather disc together with the Polistar beige. High shine polishing with the cotton buff and the Polistar Emulsion.

Inhalt, contents:

2x 4280 / 1x Polistar Lintygrau 90g / 1x 520 100/7 /  
1x Polistar Beige 85g / 1x 152 80 BW / 1x Polistar Emulsion 50ml



## 3D MiniPol Set

Ref.No. 313241

Set zum Polieren von Dental-Prothesen- und 3D-Kunststoffen mit dem Mikromotor. Ideale Vorpolitur durch Kombi-Bürste ScoCo mit der Polistar Lintygrau. Glanzpolitur mit der Miniatur-Microfaserlederschwabbel und der Polistar Beige. Perfekter Hochglanz mit der Miniatur-Baumwollmulle und der Polistar Emulsion.

Set of products to polish acrylic dentures and 3D-resins with the lab handpiece. Perfect pre-polishing with the combi brush ScoCo and polishing compound Polistar Lintygrey. Shine polishing with the miniature microfiber leather disc and Polistar beige. High shine polishing with the miniature cotton buff and the Polistar Emulsion.

Inhalt, contents, contenu, contenido, contenuto:

MiniPol 54: 2x ScoCo Bürste120/252 22 HP / 1x Polistar Lintygrau 90g  
MiniPol 33: 2x 520 22 HP / 1x Polistar Beige 85g  
MiniPol 12: 2x 150 22 HP / 1x Polistar Emulsion 50ml





## ThermoPol Set

Ref. Nr. 313203

**Zeit gewonnen, Glanz gesteigert: Das neue HATHO ThermoPol Set beschleunigt und verbessert das Finish thermoplastischer Zahnprothesen.**

**Save time, increase brightness: The new HATHO ThermoPol Set improves the surface of thermoplastic dentures quicker than ever before.**

### Inhalt, contents:

**2 x Art. Nr. 4280 / 1 x Ref. Nr. 313168 / 1 x Art. Nr. 869 100/14 /  
1 x Ref. Nr. 313200 / 1 x Art. Nr. 868 4" x 50 H / 1 x Ref. Nr. 313196**

### 1. Schritt 1<sup>st</sup> Step



Spannen Sie die HATHO Einlagebürste Art. Nr. 4280 auf Ihr Poliergerät.  
Stellen Sie die Geschwindigkeit auf 1.400 U/Min.

Befüllen Sie die aufgespannte Einlagebürste mit zusätzlichem Schleifmittel, indem Sie die Vorpolierpaste HATHO Polistar Lintygrau Ref. Nr. 313168 ca. 2 Sekunden an die rotierende Bürste halten.

Polieren Sie die gesamte Oberfläche der zu bearbeitenden thermoplastischen Zahnprothese gleichmäßig ca. 3 bis 4 Minuten, bis alle Unebenheiten entfernt sind. Beenden Sie Schritt 1 wie üblich mit der Reinigung des Werkstücks.

Attach the HATHO Multi Layer Brush art. no. 4280 to your polishing lathe. Adjust the speed to a low speed of 1,800 rpm. To fill the multi layer brush with additional polishing compound, hold the pre-polishing compound HATHO Polistar Lintygrey ref. no. 313168 against the rotating multi layer brush for approx. 2 seconds. Use the compound filled brush to evenly polish the thermoplastic denture surfaces for approx. 3 to 4 minutes until smooth. Finish step 1, as usual, by cleaning the workpiece.

### 2. Schritt 2<sup>nd</sup> Step



Spannen Sie die HATHO COSIMA Soft Polierschwabbel Art. Nr. 869 100/14 auf Ihr Poliergerät.  
Stellen Sie die Geschwindigkeit auf 1.400 U/Min.

Tragen Sie je nach Bedarf jeweils ca. 1 cm HATHO Polistar Creme Ref. Nr. 313200 auf die vorpolierte thermoplastische Prothese auf.

Polieren Sie sanft die gesamte Oberfläche der Prothese gleichmäßig ca. 3 bis 4 Minuten, bis alle feinen Kratzer wegpoliert sind. Beenden Sie Schritt 2 mit der üblichen Reinigung des Werkstücks.

Attach the HATHO COSIMA Soft Polishing Buff art. no. 869 100/14 to your polishing lathe. Adjust the speed to a low speed of 1,800 rpm. Apply approx. 0.5" of HATHO Polistar Cream ref. no. 313200 to the pre-polished thermoplastic dentures as needed. Gently and evenly polish the denture's surface for approx. 3 to 4 minutes until all fine marks have disappeared. Finish step 2, as usual, by cleaning the workpiece.

### 3. Schritt 3<sup>rd</sup> Step



Spannen Sie die HATHO MIRA Polierschwabbel Art. Nr. 868 4" x 50 H auf Ihr Poliergerät.  
Stellen Sie die Geschwindigkeit auf 1.400 U/Min.

Befüllen Sie die Polierschwabbel mit Poliermittel, indem Sie die Hochglanz-Polierpaste HATHO Polistar Pro Rosa Ref. Nr. 313196 ca. 2 Sekunden an die rotierende Schwabbel halten.

Polieren Sie die gesamte Oberfläche der Prothese gleichmäßig ca. 3 bis 4 Minuten, bis jener Grad an Hochglanz und Brillanz erscheint, den Sie bislang nur von PMMA-Prothesen kannten!

Beenden Sie Schritt 3 mit der üblichen Reinigung des Werkstücks. Freuen Sie sich über das beste Ergebnis in der kürzesten Zeit, das Sie jemals bei einer thermoplastischen Zahnprothese erzielt haben!

Attach the HATHO MIRA Polishing Buff art. no. 868 4" x 50 H to your polishing lathe. Adjust the speed to a low speed of 1,800 rpm. Fill the polishing buff with polishing compound by holding the HATHO Polistar Pro Pink high shine polishing compound ref. no. 313196 against the rotating buff for approx. 2 seconds. Gently and evenly polish the denture's surface for approx. 3 to 4 minutes until they exude the high shine. This brilliant appearance, which up until now, could only be achieved with PMMA acrylic dentures! Finish step 3, as usual, by cleaning the workpiece. Enjoy the best result in polishing thermoplastic dentures achieved in the shortest time.

# Werkzeugständer, Schutzkappe, Fingerringe, Muster Kit Instrument holder, Protector, Finger Stalls, Sample Kit

## Werkzeugständer leer Empty instrument holder



Ref.No. 313048 313045



313057



313056

## Schutzkappe mit Partikelfänger Protector and particle collector



Ref.No. 314386

## Fingerringe aus Leder Leather finger stalls

Art.No.	Größe sizes	
PF 1	Kleiner Finger little finger	1
PF 2	Ringfinger ring finger	2
PF 3	Zeigefinger index finger	3
PF 4	Daumen thumb	4



## Polistar-Muster-Kit Polistar-Sample-Kit



Ref.No.  
314315

# Erfahren im Erfinden Experience in Discovery

Verbesserung des Bestehenden und Entwicklung von Neuem: so lauten die Prämissen von HATHO.

Sie betreffen sämtliche Produktionsmittel und -abläufe und vor allem jedes einzelne Produkt.

Ein lebendiger Kreislauf der Optimierungen und Innovationen, der nicht zum Stillstand kommt.

Die logische Konsequenz des hohen Anspruchs sind eine Vielzahl neuer Anwendungen und Produkte, nationale und internationale Patente sowie ein Qualitätsmanagement gemäß ISO 9001:2015.

Improvement of what exists and the development of something new: these are the premisses of HATHO.

They concern all production means and processes and most importantly, every single product.

A lively cycle of optimization and innovation which never comes to a standstill.

The logical consequence of high demand are a large number of new applications and products; national and international patents; as well as quality management according to ISO 9001:2015.



Downloads: AGB

Downloads: GTC - Please select your language

Téléchargement: CGV - Veuillez choisir votre langue

Descarga: TCG - Selección su idioma

Download: TCG - Selezionare la lingua desiderata

**ANTONY**

Konzept•Layout•Fotografie

www.antony.media

Printed in Germany 2023

Alle Maße in diesem Katalog sind ca. Maße

All sizes in this catalogue are approximated sizes.

Wir behalten uns das Recht vor, Produktänderungen, die ausschließlich der Verbesserung des Artikels dienen, den Vertragszweck nicht gefährden und zumutbar sind, ohne Vorankündigung durchzuführen.

Without prior notice, we reserve the right to alter or change products for improvement, without substantial change to a delivery contract.

Auf eventuelle Druckfehler oder Änderungen der Artikelbezeichnungen werden wir Sie bei Ihrer Bestellung hinweisen.

Concerning any misprints, changes in art. No. or any other formal changes, we will inform you upon order.

Scotch Brite™ (siehe z.B. Seite 24) ist eine eingetragenes Warenzeichen der Firma 3M USA.

Scotch Brite™ (i.e. page 24) is a registered trademark of the company 3M USA





Gewerbepark Breisgau  
Freiburger Straße 18  
79427 Eschbach  
Germany

Tel. +49 76 34 50 39-0  
Fax. +49 76 34 50 39-22

[info@hatho.de](mailto:info@hatho.de)  
[www.hatho.de](http://www.hatho.de)